

# EXPOLIFT

ASANSÖR İÇ ve DIŞ TİC. SAN. LTD. ŞTİ.

Tatlıcak Mahallesi Uzungeçit Sokak

No: 33C Karatay/KONYA

Tel: +90 551 113 43 82

[www.expolift.com.tr](http://www.expolift.com.tr)

EXPOLIFT ASANSÖR İÇ  
VE DIŞ TİC SAN LTD ŞTİ.  
Mr. Ahmed KAHEEL  
TATLİCAK MAH. UZUNGEÇİT  
SK. NO 33/C - KARATAY  
KONYA , TÜRKİYE

ALRUKN ALARQA COMPANY  
FOR GENERAL CONTRACTS & TRADE LTD  
Mr. Tarik Khazal Aziz  
Alfaisaliyah, Next to  
Directorate of Education  
Mosul, Nineveh Governorate,  
Iraq

Subject: Authorization to distribute EXPOLIFT material

EXPOLIFT, whose registered office is at EXPOLIFT ASANSÖR İÇ VE DIŞ TİCARET SANAYİ LIMITED ŞİRKETİ Turkey, and represented by Mr. Ahmed KAHEEL as General Manager, authorizes the company ALRUKN ALARQA FOR GENERAL CONTRACTS & TRADE LTD whose registered office is at Baghdad, IRAQ and represented by Mr. Tarik Khazal Aziz as General Manager, to market our products (complete lifts and spare parts) in Jordan and Iraq. In return, EXPOLIFT undertakes to provide ALRUKN ALARQA FOR GENERAL CONTRACTS & TRADE LTD with any technical support it may require.

Validity of this authorization: One year from the date of this authorization.

Renewal: This authorization is automatically renewed annually with the consent of both parties.

Disputes: All disputes will be resolved amicably or, failing that, by legal action in Turkey.

Konya, 08 July 2023

EXPOLIFT

EXPOLIFT ASANSÖR  
İÇ VE DIŞ TİC SAN. LTD. ŞTİ.  
Tatlıcak Mah. Uzungeçit Sk. No:33/C  
Tic. Sic. No:62732 - Karatay/KONYA  
Selçuk Vergi Dairesi : 381 096 1265

ALRUKN ALARQA





**ALRUKN ALARQA**

FOR GENERAL CONTRACTS L.T.D

شركة الركن الأرقى

للمقاولات العامة المحدودة

[www.ruknarqa.com](http://www.ruknarqa.com)

**E X P O L I F T**





EXS 01



STEEL CABINS

EXS 02



EXS 03



EXS 04



EXW/01

WOOD CABINS

EXW/02



EXW/03



EXW/04





EXG 01



EXG 03

GLASS CABINS

EXG 02



EXG 04





EXPOS 01



DECORATIVE STEEL

EXPOS 02



EXPOS 03



EXPOS 04



EXCW/01



CARVING WOOD

EXCW/02

EXCW/03



EXCW/04







EXES 01



EXCS 03

CARVING STEEL

EXCS 02

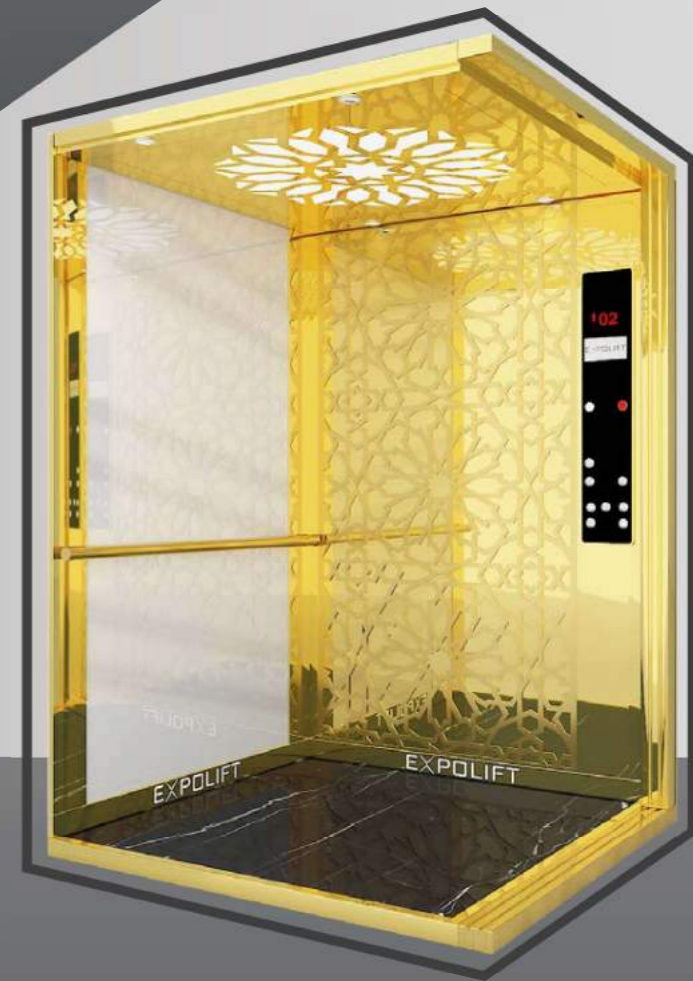

EXCS 04





EXL 01

LUX CABINS



EXL 02

EXL 03



EXL 04



CABIN

MODELS



EXL 05



EXCW 05

EXW 05



EXW 06



CABIN

MODELS



EXW/07



EXW/08

EXW/09



EXW/10



EXPOLIFT



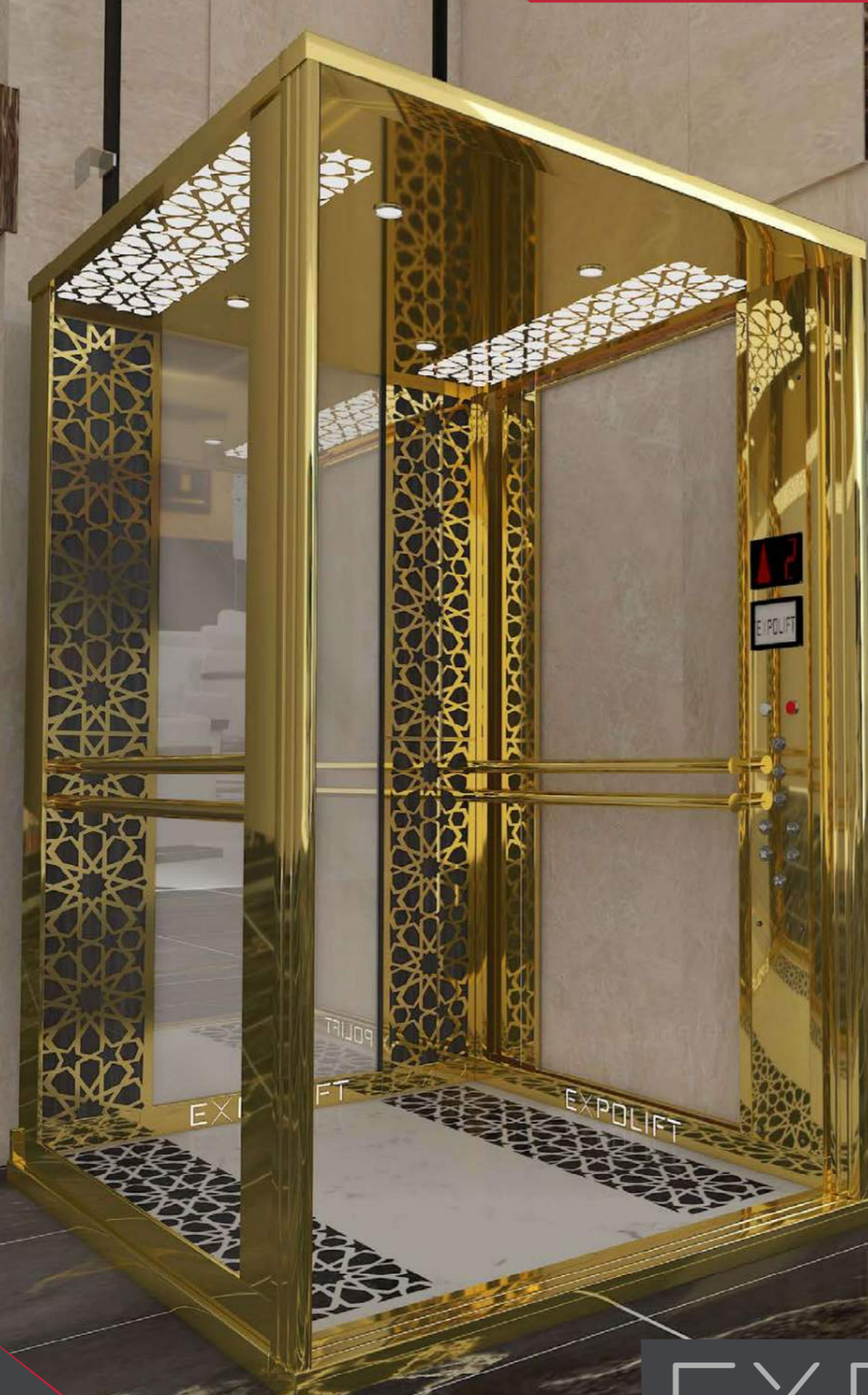

EXPOLIFT

EXP 03



EXP 04





SM 102



SM 103



SM 108



SM 110



SM 111



SM 115



SM 118



SM 119



SM 187

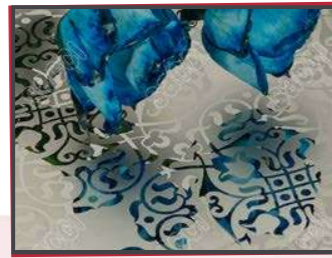

SM 188



SM 189



SM 190



SG 203

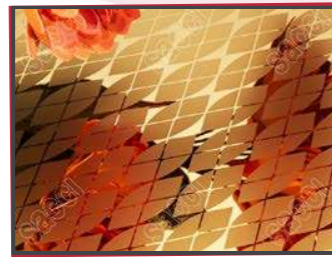

SG 208

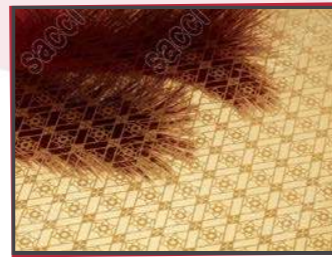

SG 220



SG 226



SG 281



SG 282



SG 285



SG 286



SG 287



SG 238



SG 288



SG 290

## LAMINATED MODELS



VT 07



VT 16

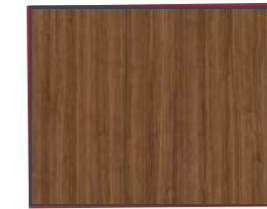

VT 53



VT 84



VT 77

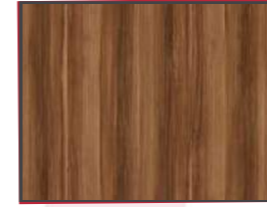

VT 275

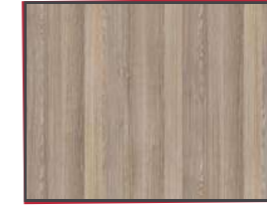

VT 293



VT 395

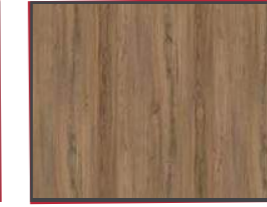

VT 672

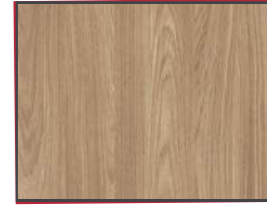

VT 97

## HIGH GLOSS MODELS

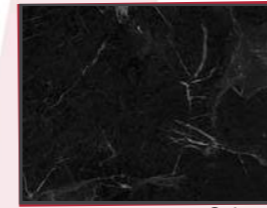

HGS 01



HGS 02



HGS 03



HGS 04

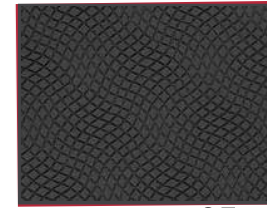

HGS 05



HGS 06



HGS 07

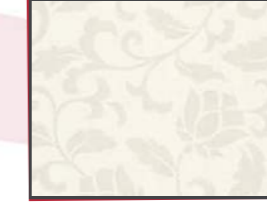

HGS 08



HGS 09

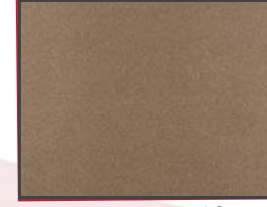

HGS 10

## FLOOR MODELS



STAR GALAXY



PASHA BLACK



KASHMIR WHITE



AKSARAY YAYLAK

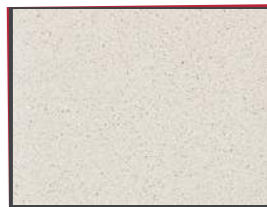

402 ARCADIA



TEN BROWN



LIGHT EMPERADOR



MUGLA



MELISA BEJ

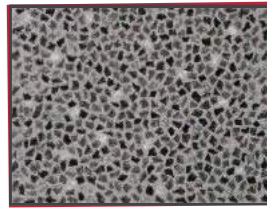

PVC





EX 11

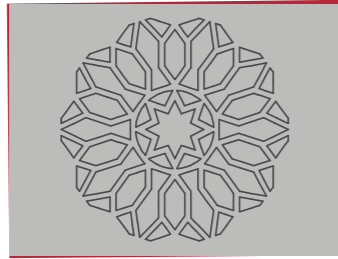

EX 04

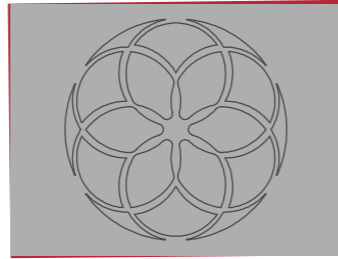

EX 06

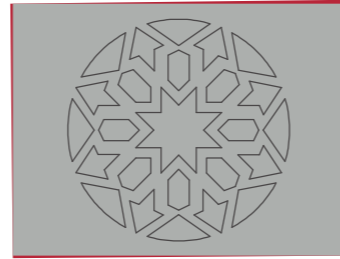

EX 07



EX 02

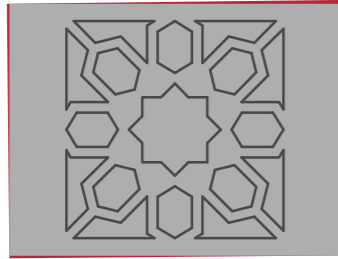

EX 17

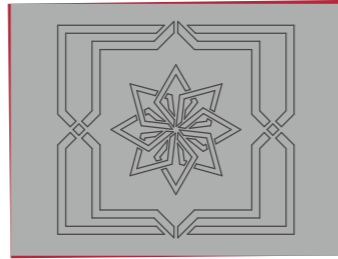

EX 08

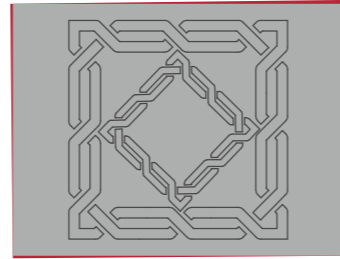

EX 09

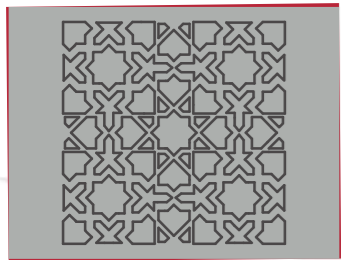

EX 03

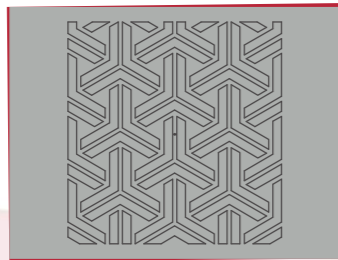

EX 10

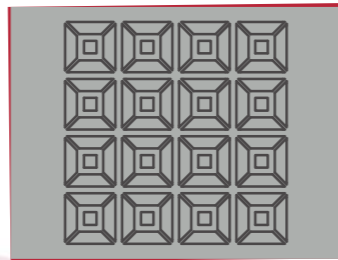

EX 16

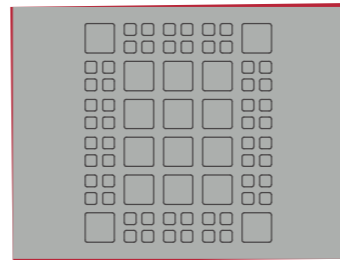

EX 15

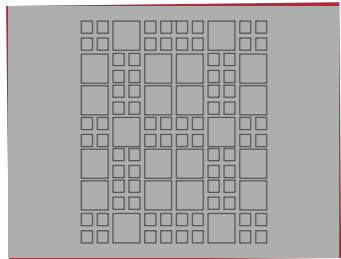

EX 18

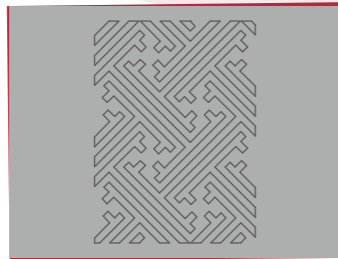

EX 14

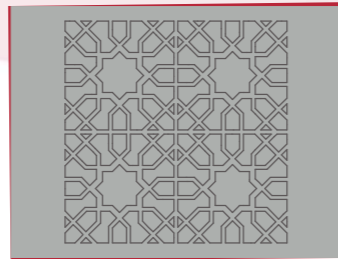

EX 22



EX 27

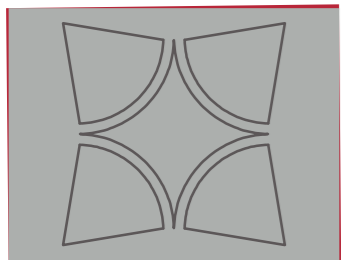

EX 53

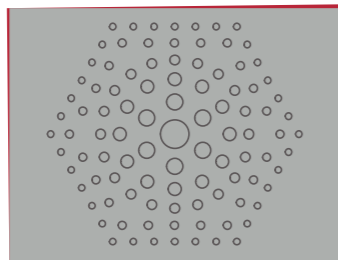

EX 32



EX 34



EX 40



EX 41



EX 43



EX 55

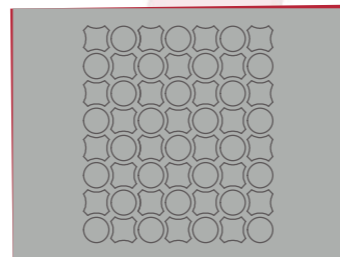

EX 59



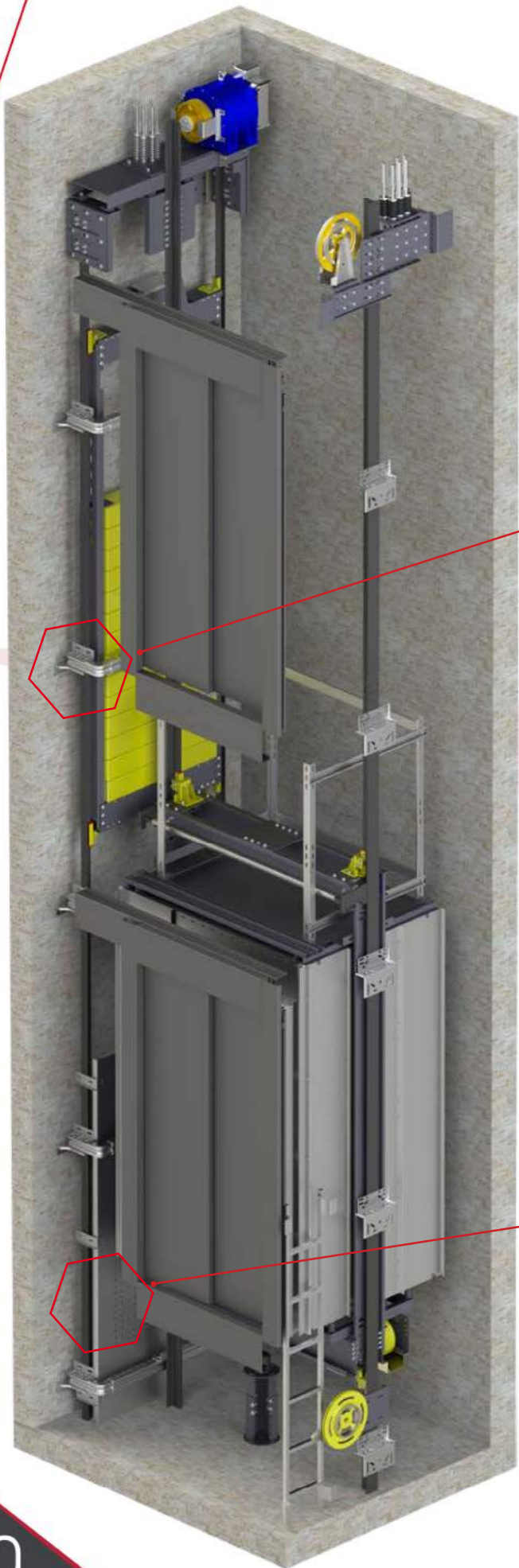

COUNTER WEIGHT  
SIDE SYSTEM

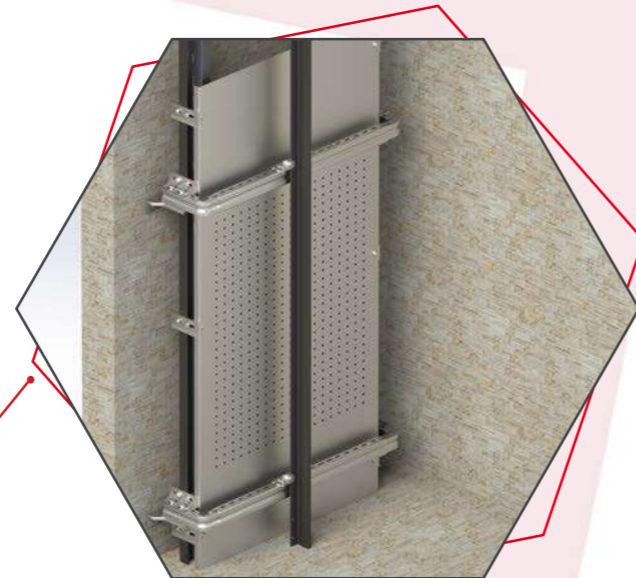

SIPARATION METAL  
SHEET

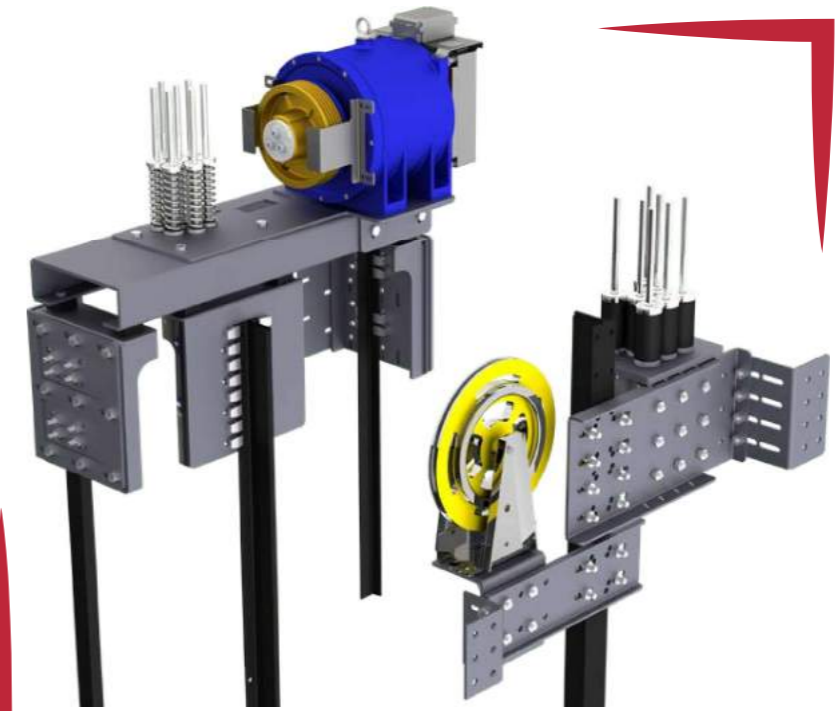

MRL. MACHINE MOTOR FRAME



2/1 CAR FRAME



2/1 COUNTER  
WEIGHT FRAME

# BACK TYPE MRL. SYSTEM



SPEED GOVERNOR  
FRAME

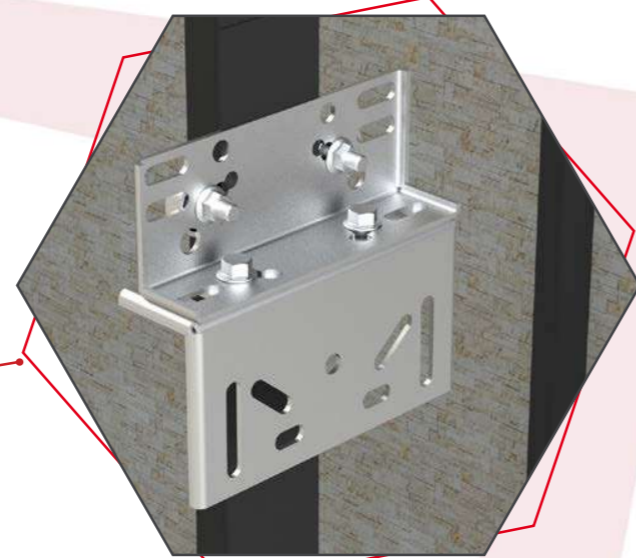

RAIL BRACKET

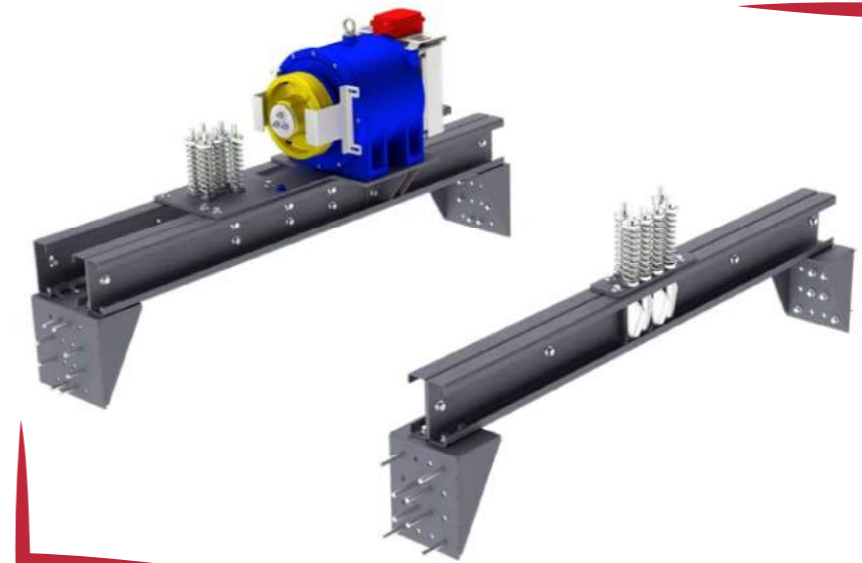

MRL. MACHINE MOTOR FRAME



2/1 CAR FRAME



2/1 COUNTER  
WEIGHT FRAME



2/1 COUNTER  
WEIGHT FRAME  
DOUBLE ROW

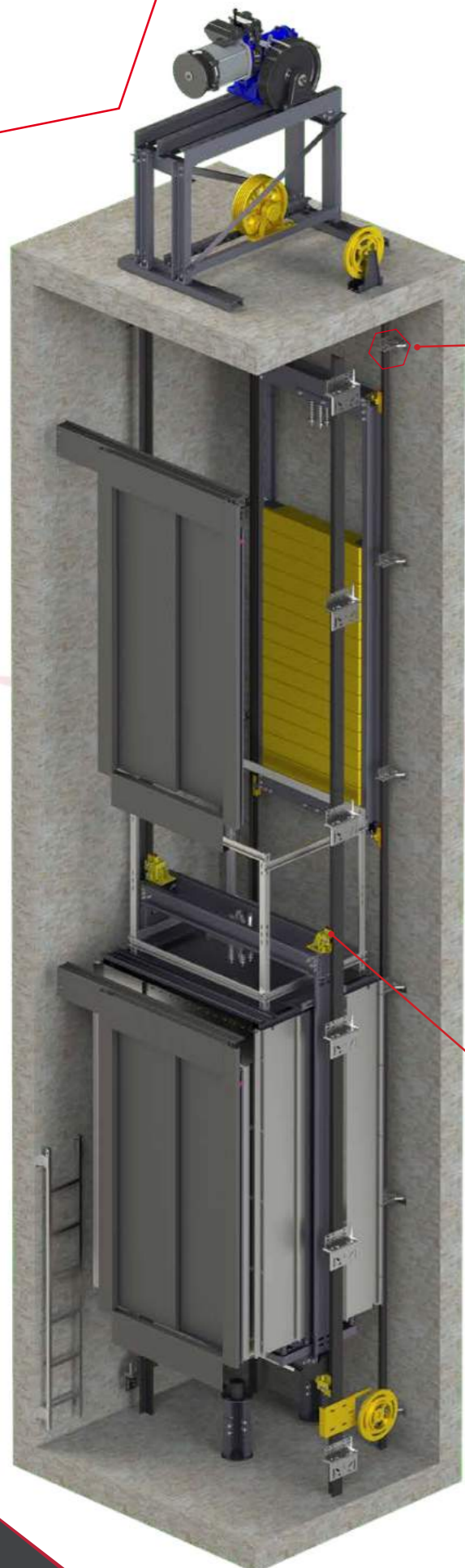

RAIL BRACKET

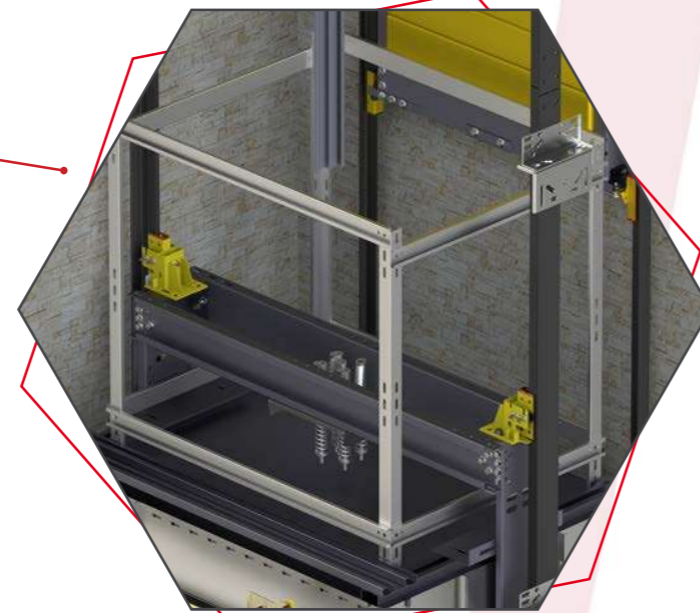

CAR BALUSTRADE

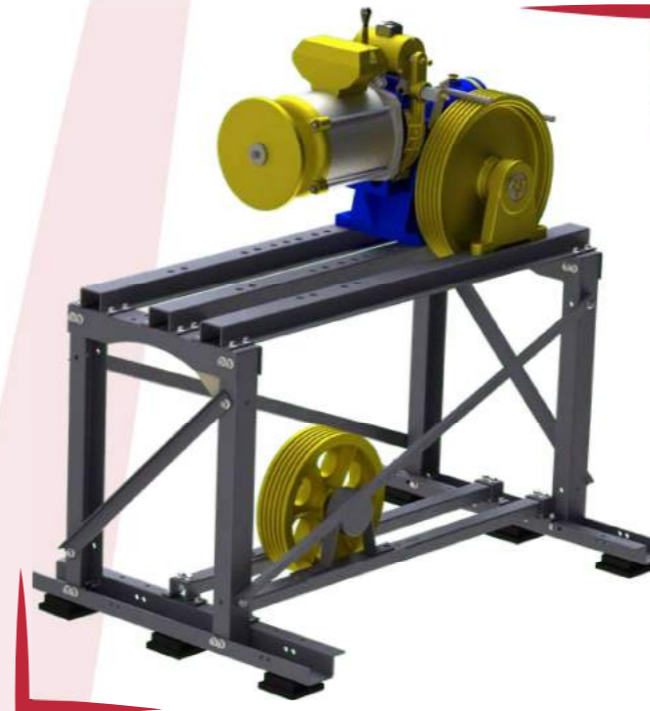

MR. MACHINE MOTOR FRAME



1/1 CAR FRAME



1/1 COUNTER WEIGHT FRAME

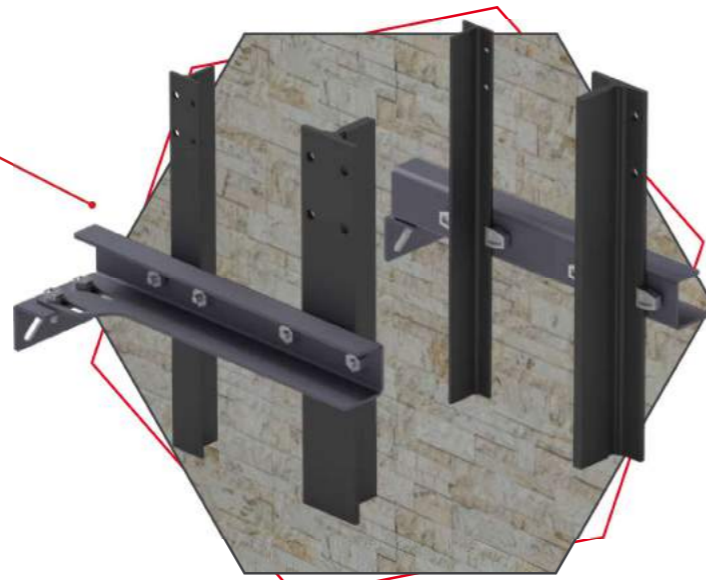

L TYPE CAR FRAME  
BRACKET

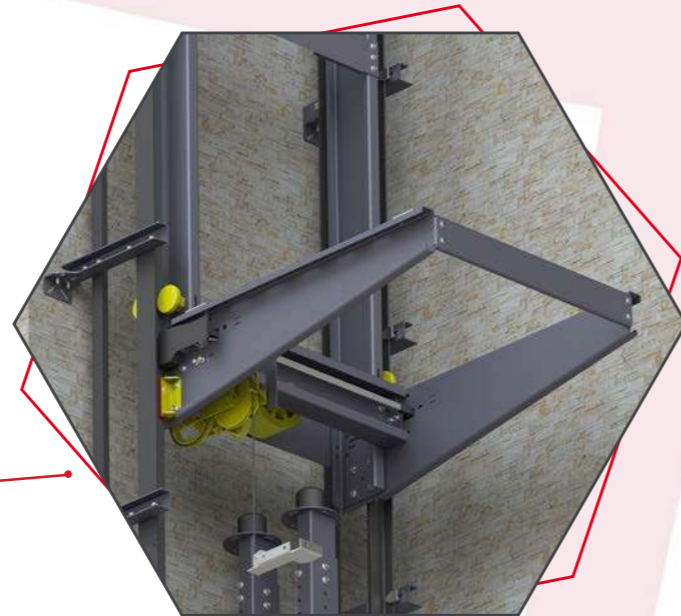

SPECIAL SPEED  
GOVERNOR



MRL. MACHINE MOTOR FRAME

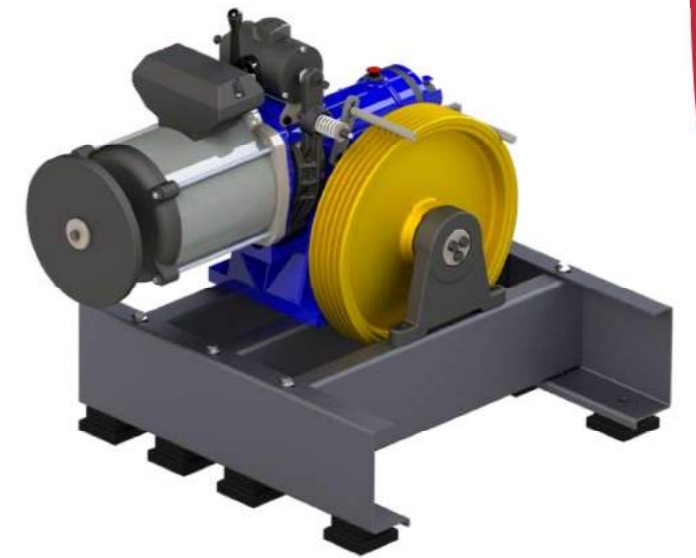

MR. MACHINE MOTOR FRAME



2/1 L TYPE  
CAR FRAME



1/1 L TYPE  
CAR FRAME

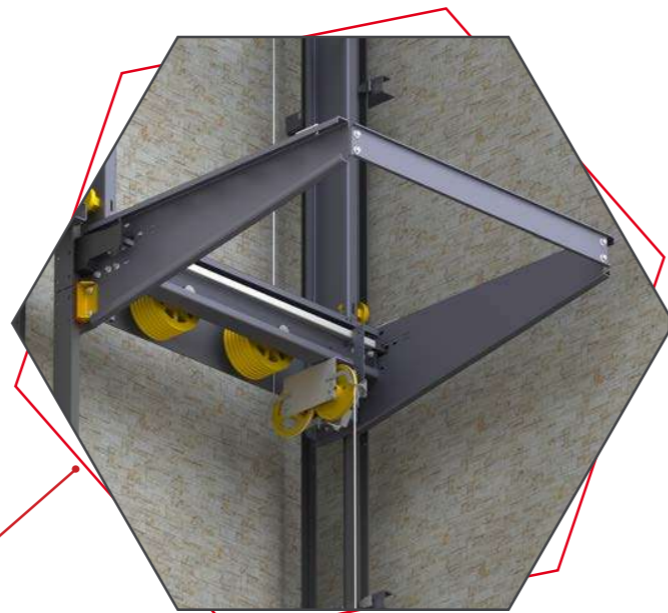
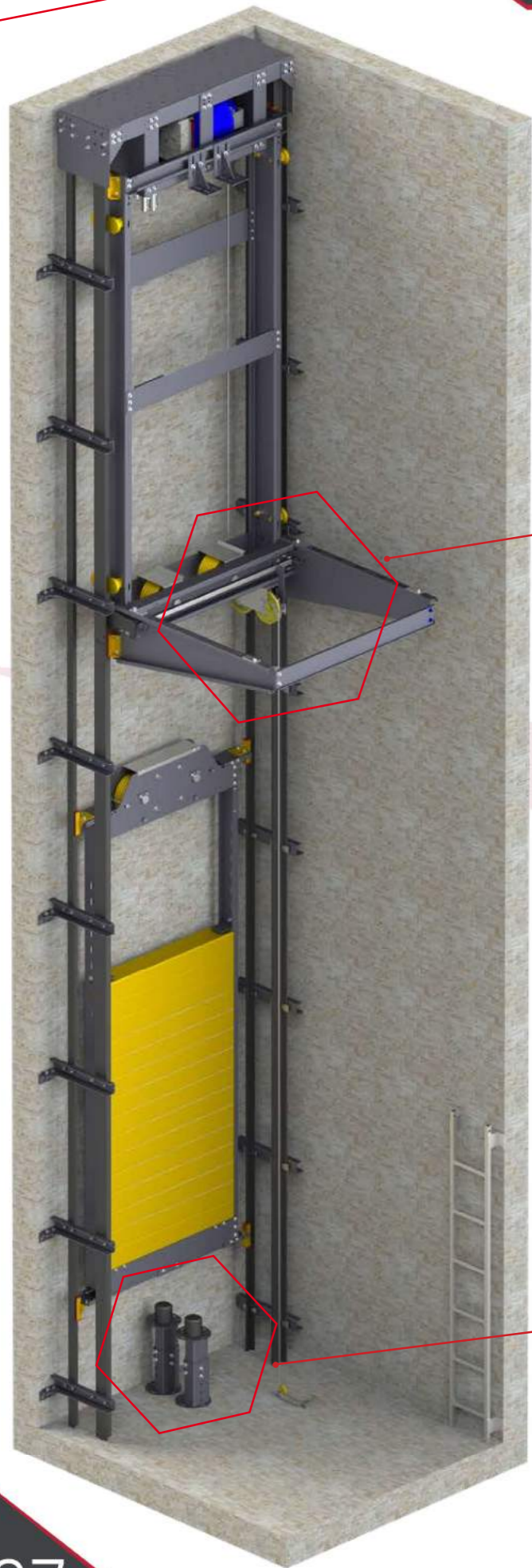

SPECIAL SPEED GOVERNOR

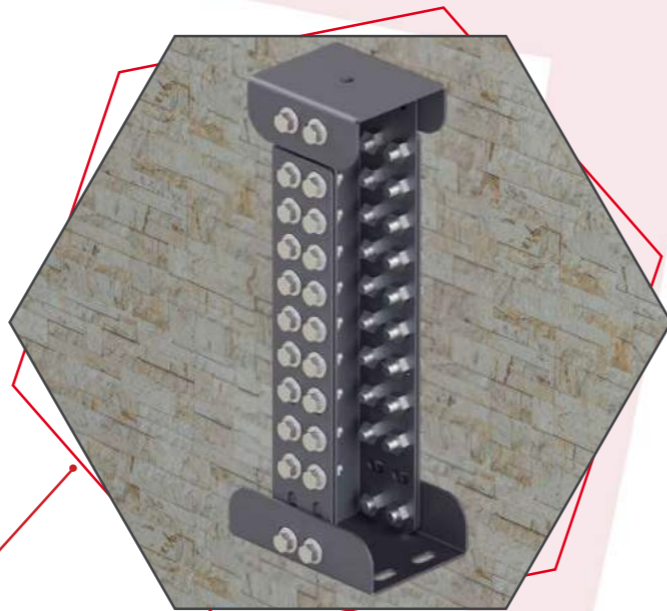

BUFFER BASE



SPECIAL 2/1 L TYPE CAR FRAME



2/1 L TYPE CAR FRAME DOUBLE PULLEY



2/1 COUNTERWEIGHT FRAME DOUBLE PULLEY

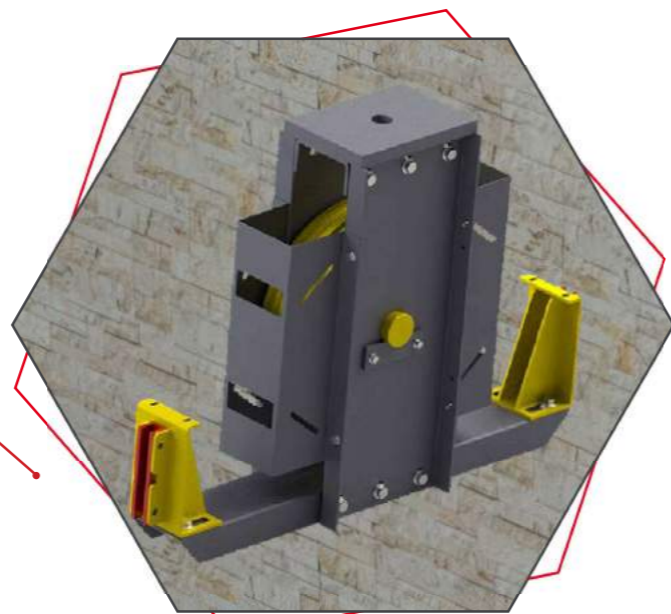

HYD PULLEY

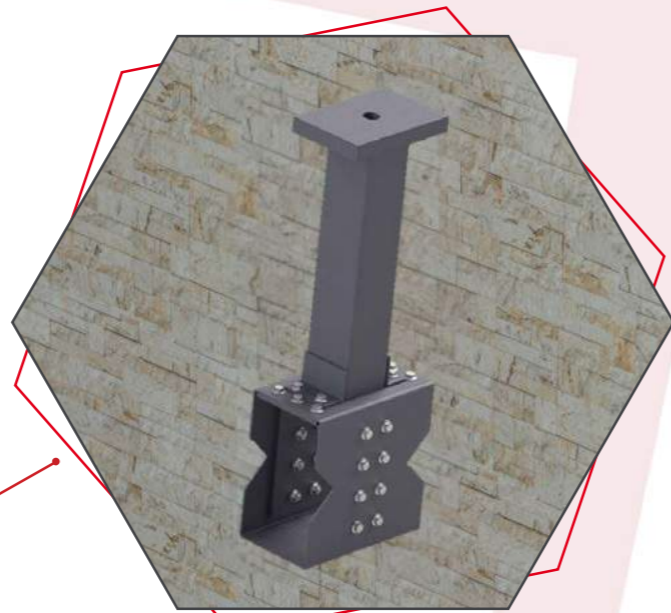

PISTON BASE

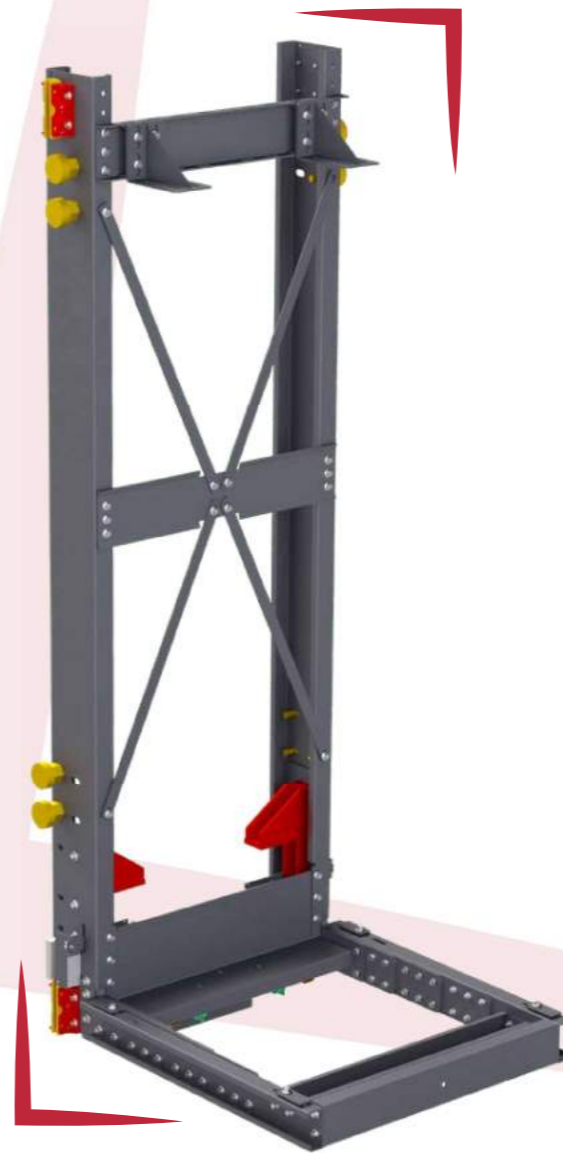

HYD L TYPE CAR FRAME  
PIT (30 CM)



HYD L TYPE  
CAR FRAME

SILVER

□□□R





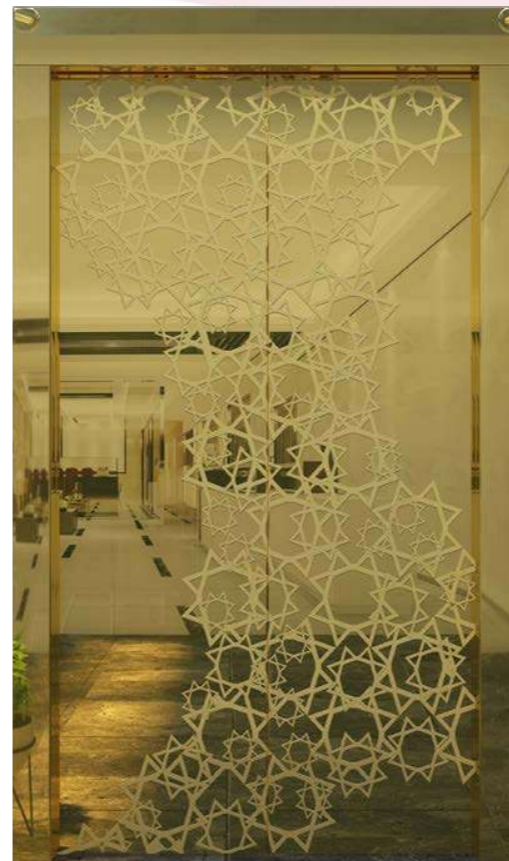

BLACK

DOOR

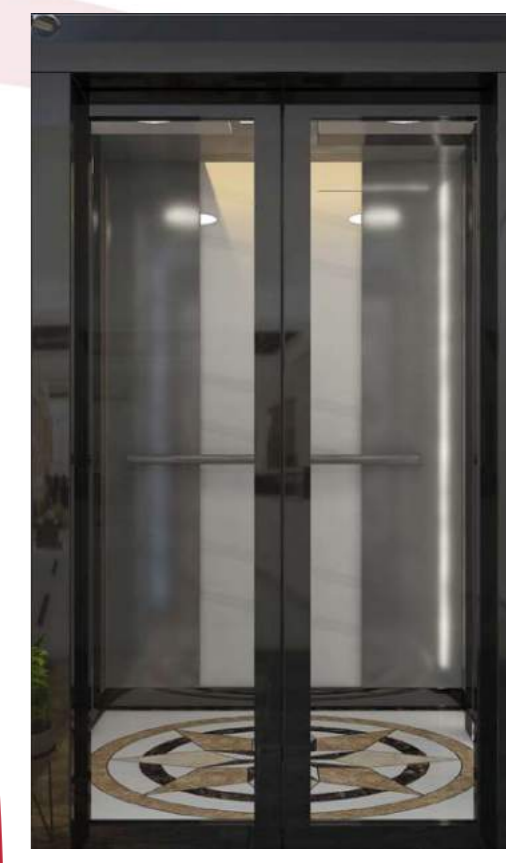
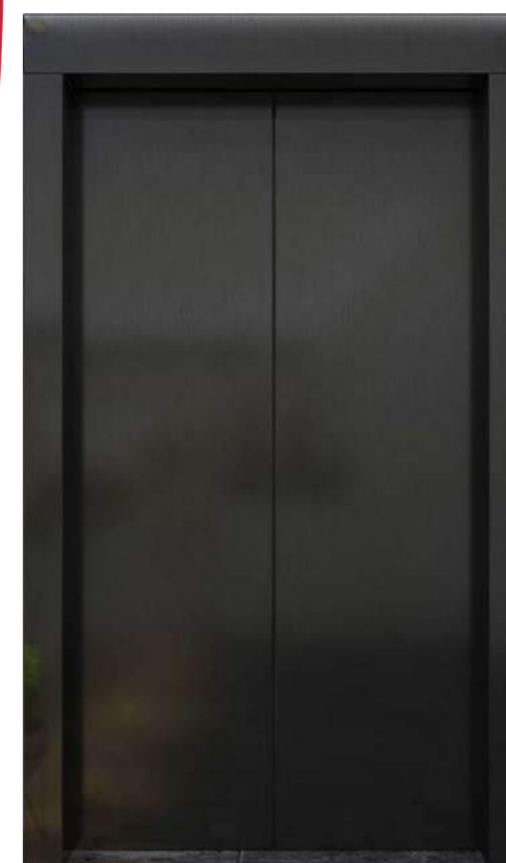
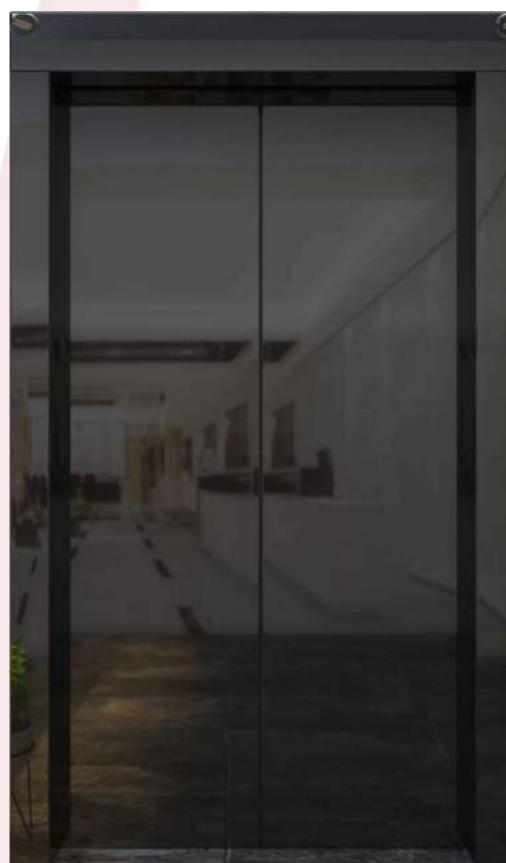

COPPER

DOOR

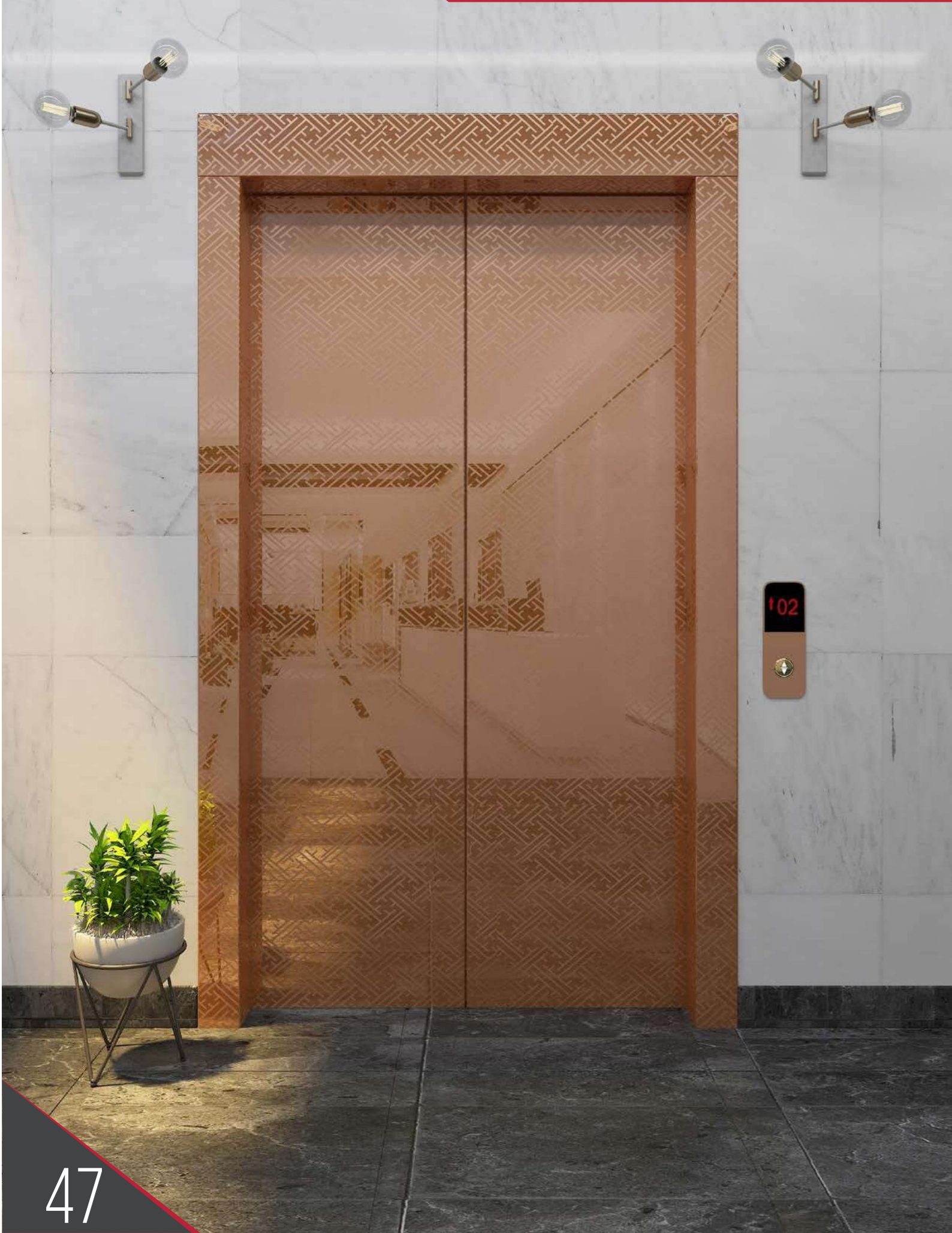

# CABIN

# □□□R

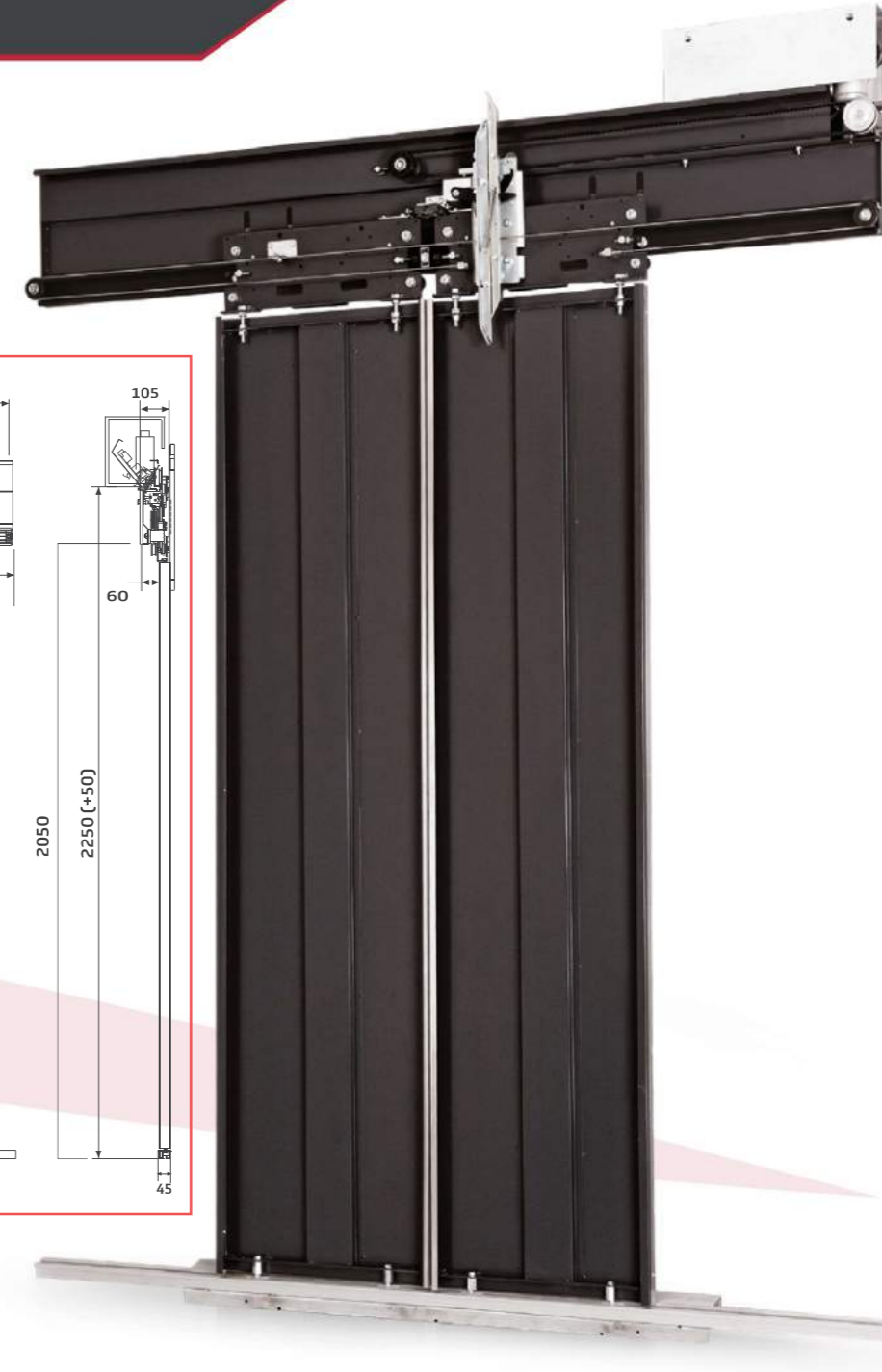
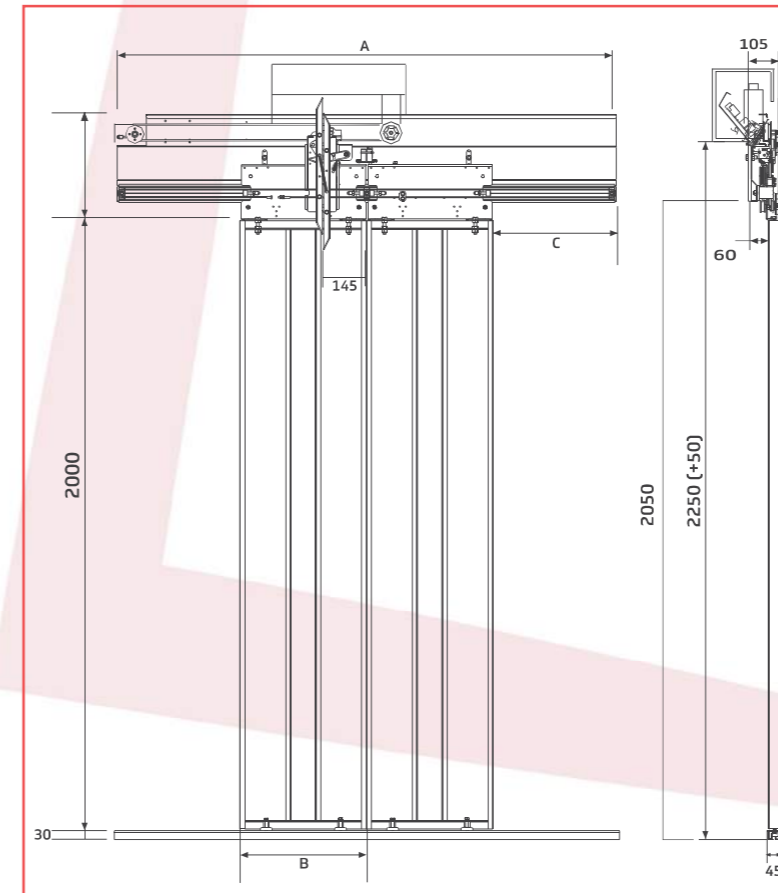
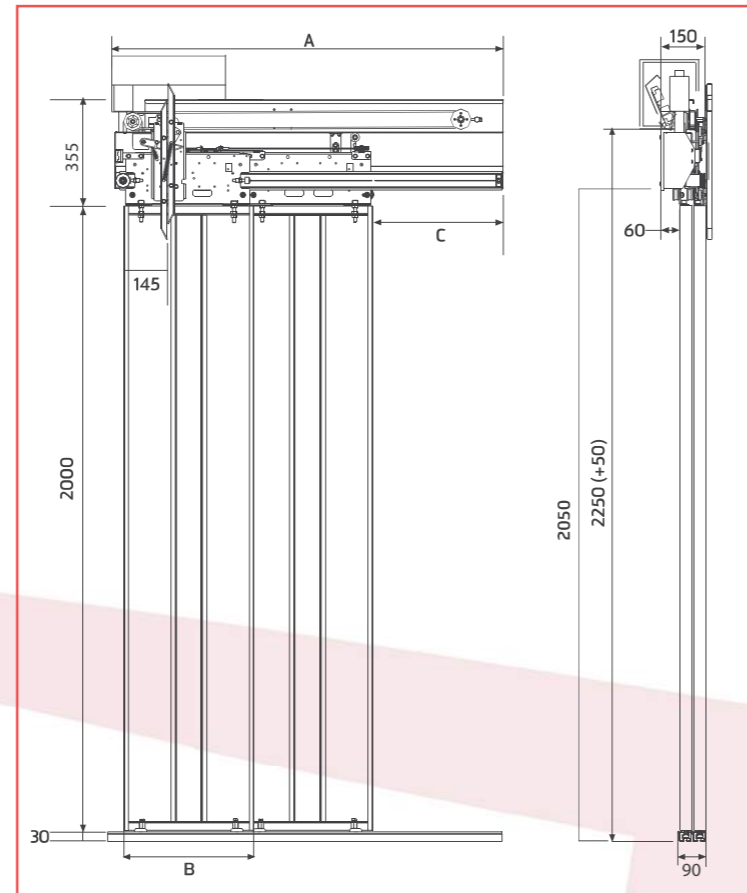

PL (mm)	A (mm)	B (mm)	C (mm)
700	1100	370	380
800	1250	420	430
900	1400	470	480
1000	1550	520	530
1100	1700	570	580
1200	1850	620	630
1300	2000	670	680
1400	2150	720	730
1500	2300	770	780
1600	2450	820	830

PL (mm)	A (mm)	B (mm)	C (mm)
700	1450	370	380
800	1650	420	430
900	1850	470	480
1000	2050	520	530
1100	2250	570	580
1200	2450	620	630
1300	2650	670	680
1400	2850	720	730
1500	3050	770	780
1600	3150	820	830

# CABIN

# DOOR

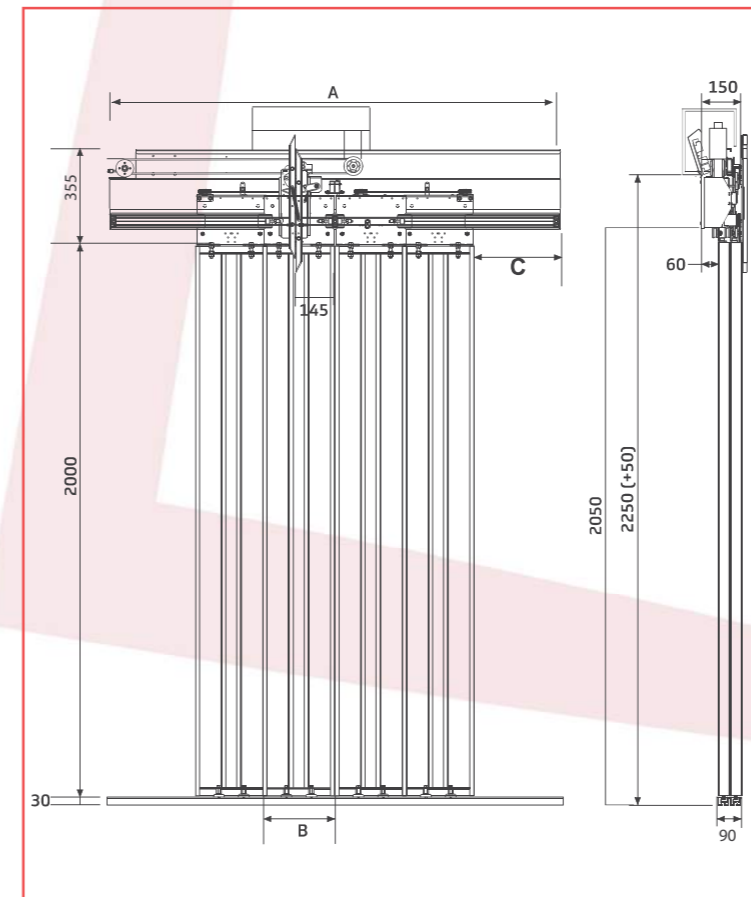
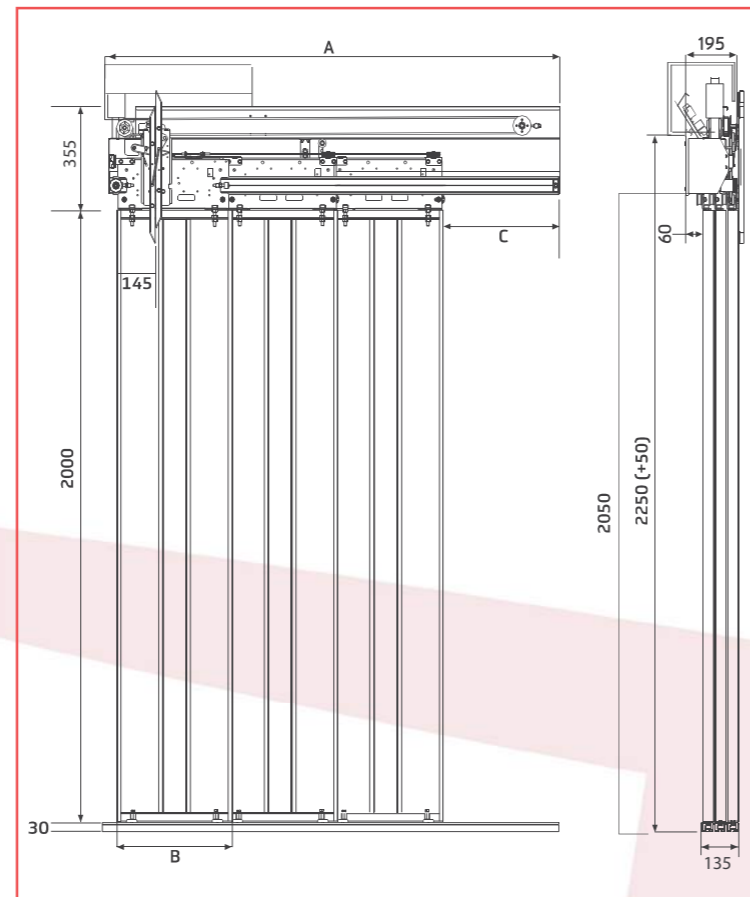

PL (mm)	A (mm)	B (mm)	C (mm)
800	1117	287	297
900	1250	320	330
1000	1383	353	363
1100	1517	387	397
1200	1650	420	430
1300	1783	453	463
1400	1917	487	497
1500	2050	521	531
1600	2183	554	564

PL (mm)	A (mm)	B (mm)	C (mm)
1000	1550	270	280
1100	1700	295	305
1200	1850	320	330
1300	2000	345	355
1400	2150	370	380
1500	2300	395	405
1600	2450	420	430

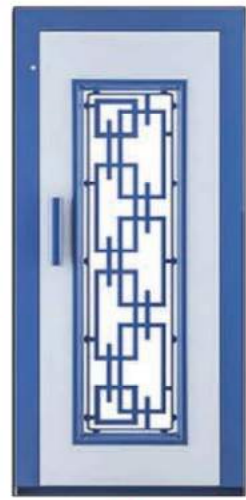

F3



F2



F1



H1



G1



P1



O1



N1



DK05B



DK05



DK06



DK02A



YKDK02A



A4



A3



A2



A1



FOLDING DOOR

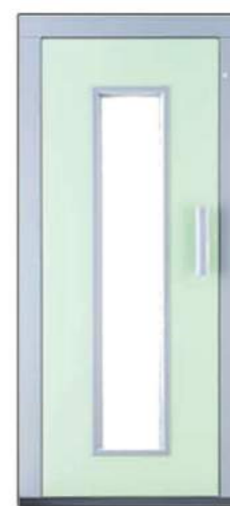

K1



E1



TWO1



# CONTROLLER PANEL



ARCODE



ADRIVE



ARL 500



ARL 300

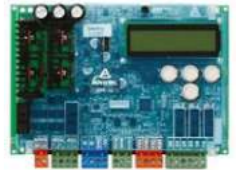

KM 10



# BUTTONS

# MOTORS

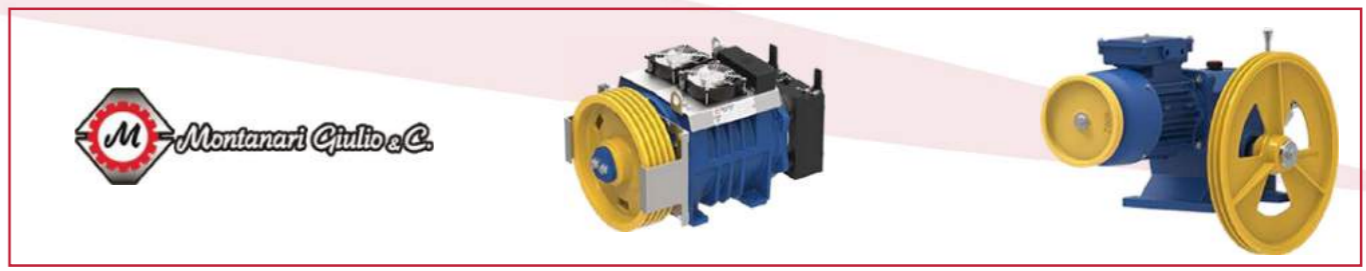



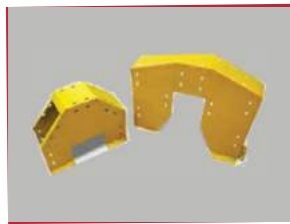

PULLEY COVER  
FOR MR



FLEXIBLE CABLE  
BRACKET



ROLLER GUIDE  
SHOES



GUIDE ROLLER



PLASTIC COUNTER  
WEIGHT SHOES



PLASTIC SHOES

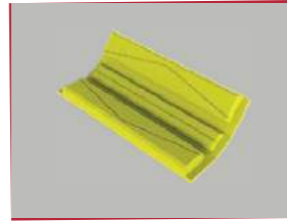

PLAURITHANE  
SHOES

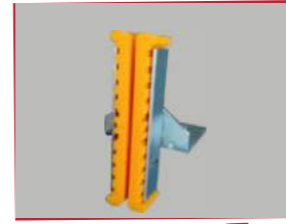

METAL SHEET  
GUIDE SHOES



STABING WEDGE L  
FOR CABIN CEILING



WEDGE FOR MACHIN  
FRAME

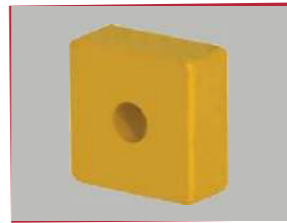

WEDGE FOR  
MACHIN FRAME



ROPE COLLECTOR



ROPE CONNECTOR

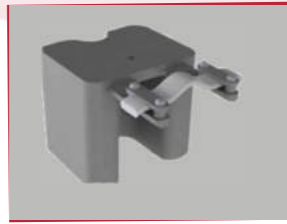

LUBRICATOR



OIL COLLECTING CUP



CABIN TURBIN  
FAN



FISH PLATE



NAIL CASTING



SQUARE NAIL



NAIL METAL SHEET

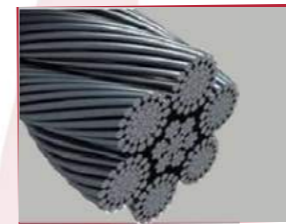

STEEL ROPE



FLEXIBLE CABLE

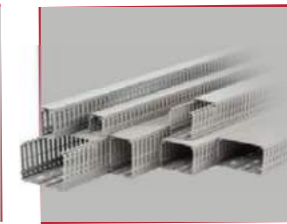

PLASTIC CABLE  
CHANNEL 40X40 MM



SPIRAL TUBE  
14 MM



CABLES



ROLLER LIMIT  
SWICH



RETIRNIG CAM



DOOR CLOSER



PHOTOCELL

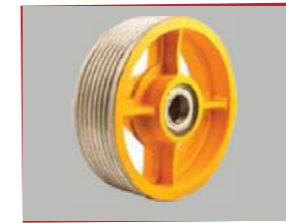

DIVERSION PULLEY

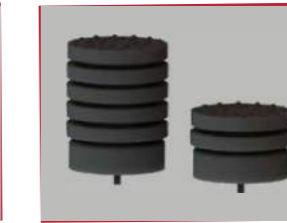

BUFFER



HYDAULIC BUFFER



SAFETY GEAR  
L FRAME TYPE



SAFETY GEAR



ROPE ATTACHMENET  
SWINGING



ROPE ATACHMENT  
STABLE



STEEL DOWEL



PIT FREE SPEED  
GOVERNOR MRL



MRL.  
SPEED GOVERNOR



MR.  
SPEED GOVERNOR

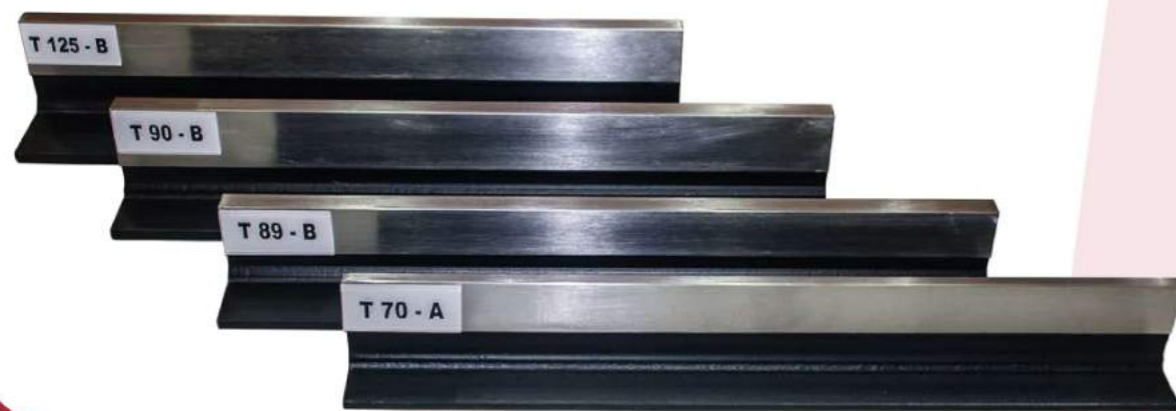

# EXPOLIFT



**ALRUKN ALARQA**  
FOR GENERAL CONTRACTS L.T.D

**شركة الركن الأرقى**

للمقاولات العامة المحدودة

[www.ruknarqa.com](http://www.ruknarqa.com)